

# SCIENTIFIC CALCULATOR OPERATION GUIDE

<V/R Series>

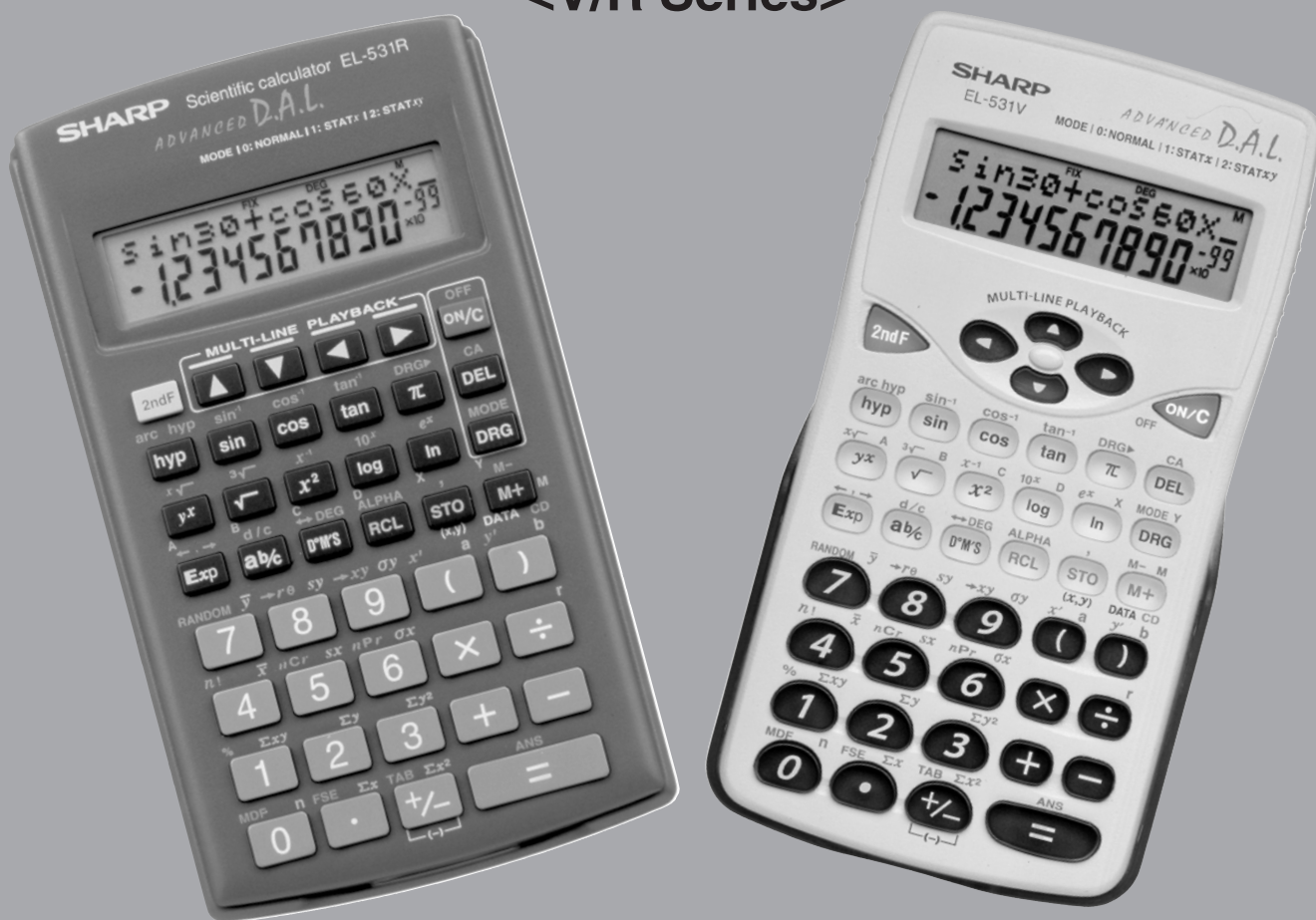



# SHARP

















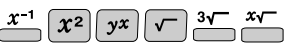

# CONTENTS

## HOW TO OPERATE

### Read Before Using

Key layout/Reset switch		2
Display pattern		3
Display format		3
Exponent display		4
Angular unit		5

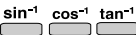
### Function and Key Operation

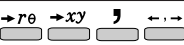
ON/OFF, entry correction keys		6
Data entry keys		7
Random key		8
Modify key		9
Basic arithmetic keys, parentheses		10
Percent		11
Inverse, square, xth power of y, square root, cube root, xth root of y		12
10 to the power of x, common logarithm		13
e to the power of x, natural logarithm		14
Factorials		15
Permutations, combinations		16
Time calculation		17
Fractional calculations		18
Memory calculations		19
Last answer memory		20
Trigonometric functions		21
Arc trigonometric functions		22
Hyperbolic functions		23
Coordinate conversion		24

## STATISTICS FUNCTION

Data input and erase	25
"ANS" keys for 1-variable statistics	26
"ANS" keys for 2-variable statistics	28

# How to Operate

## ≈Read Before Using≈

This operation guide has been written based on the EL-531V, EL-509V, EL-531VH, and EL-509VH models. Some functions described here are not featured on other models. In addition, key operations and symbols on the display may differ according to the model.

### 1. KEY LAYOUT

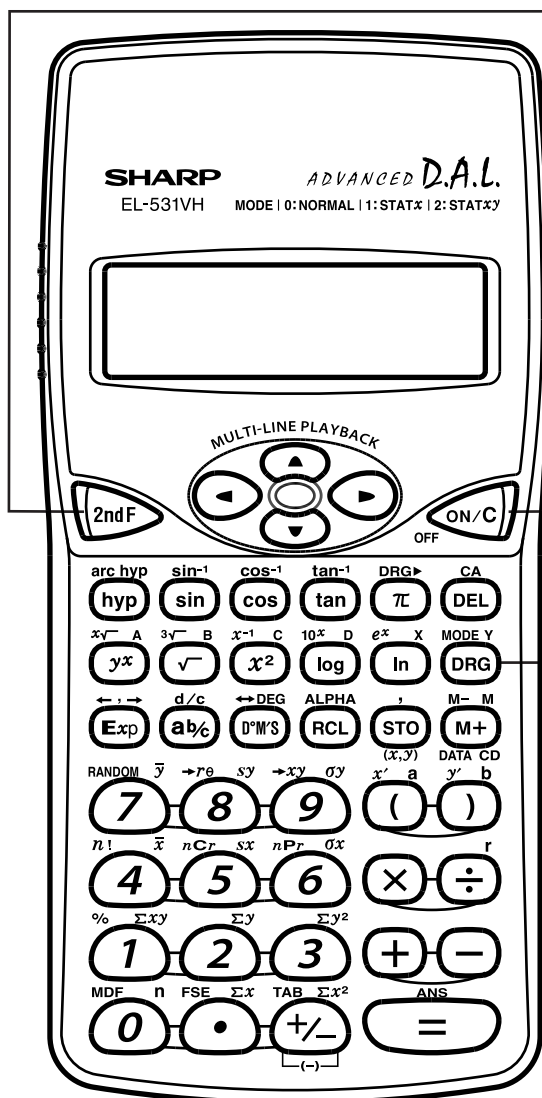

#### ● 2nd function key

Pressing this key will enable the functions written in yellow above the calculator buttons.

#### ● ON/C, OFF key

Direct function



<Power on>

2nd function



<Power off>

Written in yellow above the ON/C key

#### ● Mode key

This calculator can operate in three different modes as follows.

#### <Example>

##### [Normal mode]



•Mode = 0; normal mode for performing normal arithmetic and function calculations.

##### [STAT-1 mode]



•Mode = 1; STAT-1 mode for performing 1-variable statistical calculations.

##### [STAT-2 mode]



•Mode = 2; STAT-2 mode for performing 2-variable statistical calculations.

### 2. RESET SWITCH ● RESET

If the calculator fails to operate normally, press the reset switch on the back to reinitialise the unit. The display format and calculation mode will return to their initial settings.

#### NOTE:

Pressing the reset switch will erase any data stored in memory.

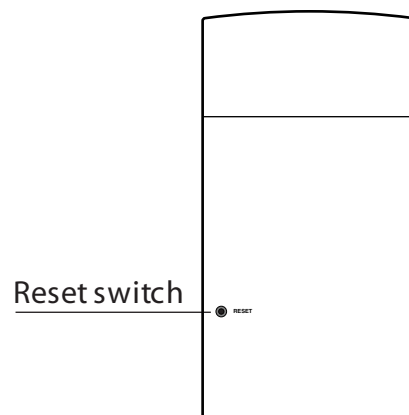

### 3. DISPLAY PATTERN

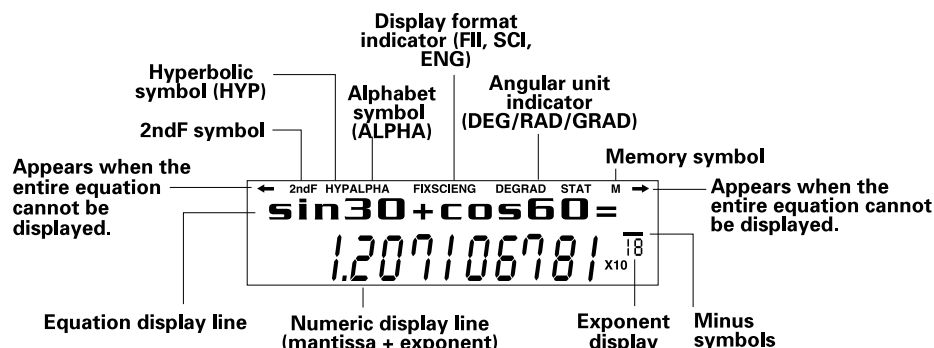

The actual display does not appear like this.  
This illustration is for explanatory purposes only.

### 4. DISPLAY FORMAT AND DECIMAL SETTING FUNCTION

For convenient and easy operation, this model can be used in one of four display modes. The selected display status is shown in the upper part of the display (Format Indicator).  
Note: If more 0's (zeros) than needed are displayed when the ON/C key is pressed, check whether or not the calculator is set to a Special Display Format.

- Floating decimal point format (no symbol is displayed)  
Valid values beyond the maximum range are displayed in the form of a [10-digit (mantissa) + 2-digit (exponent)]
- Fixed decimal point format (FIX is displayed)  
Displays the fractional part of the calculation result according to the specified number of decimal places.
- Scientific notation (SCI is displayed)  
Frequently used in science to handle extremely small or large numbers.
- Engineering scientific notation (ENG is displayed)  
Convenient for converting between different units.

**<Example>** Let's compare the display result of [10000 ÷ 8.1 =] in each display format.

(specifies normal mode)

10000  $\div$  8.1 =

**2ndF** **FSE** **2ndF** **TAB** **3**

Initial display

DEG  
0

DEG  
10000 ÷ 8.1 =  
1234.567901

(normal mode)

FIX DEG  
10000 ÷ 8.1 =  
1234.568

(FIX mode TAB = 3)

2ndF FSE

10000 ÷ 8.1 =  
1.235<sup>03</sup><sub>x10</sub>  
(SCI mode)

2ndF FSE

10000 ÷ 8.1 =  
1.235<sup>03</sup><sub>x10</sub>  
(ENG mode)

2ndF FSE

10000 ÷ 8.1 =  
1234.567901  
(normal mode)

## 5. EXPONENT DISPLAY

The distance from the earth to the sun is approx. 150,000,000 ( $1.5 \times 10^8$ ) km. Values such as this with many zeros are often used in scientific calculations, but entering the zeros one by one is a great deal of work and it's easy to make mistakes.

In such a case, the numerical values are divided into mantissa and exponent portions, displayed and calculated.

**<Example>** What is the number of electronics flowing in a conductor when the electrical charge across a given cross-section is 0.32 coulombs. (The charge on a single electron =  $1.6 \times 10^{-19}$  coulombs).

0.32 ÷

0.32 ÷ \_  
0.

1.6 Exp 19

0.32 ÷ \_  
1.6<sup>19</sup><sub>x10</sub>

=

0.32 ÷ 1.6E19 =  
2.<sup>-20</sup><sub>x10</sub>

## 6. ANGULAR UNIT

Angular values are converted from DEG to RAD to GRAD with each push of the DRG key. This function is used when doing calculations related to trigonometric functions or coordinate geometry conversions.

### Degrees (DEG is shown at the top of the display)

A commonly used unit of measure for angles. The angular measure of a circle is expressed as  $360^\circ$ .

### Radians (RAD is shown at the top of the display)

Radians are different than degrees and express angles based on the circumference of a circle.  $180^\circ$  is equivalent to  $\pi$  radians. Therefore, the angular measure of a circle is  $2\pi$  radians.

### Grads (GRAD is shown at the top of the display)

Grads are a unit of angular measure used in Europe, particularly in France. An angle of 90 degrees is equivalent to 100 grads.

The relationships between the three types of angular units can be expressed as right:

$$\begin{aligned} 90^\circ \text{ (DEG)} &= \\ \pi/2 \text{ (RAD)} &= \\ 100 \text{ (GRAD)} &= \end{aligned}$$

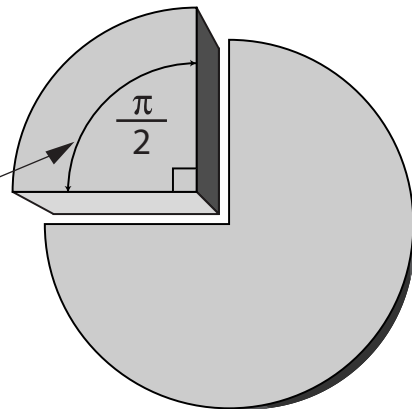

**<Example>** Check to confirm 90 degrees equaling  $\pi/2$  radians equaling 100 grads. ( $\pi=3.14159\dots$ )

Operation	Display	Angular indicator
ON/C DRG ..... DRG (in DEG mode)	0.	DEG
90 2ndF DRG▶	90▶RAD 1.570796327	RAD ( $\pi/2$ )
2ndF DRG▶	ANS▶GRAD 100.	GRAD
2ndF DRG▶	ANS▶DEG 90.	DEG

# ≈Function and Key Operation≈

## ON/OFF, Entry Correction Keys

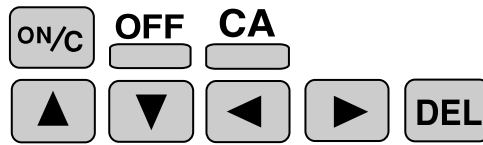

Turns the calculator on or clears the data. It also clears the contents of the calculator display and voids any calculator command; however, coefficients in 3-variable linear equations and statistics, as well as values stored in the independent memory in normal mode, are not erased.



Turns the calculator off.





Clears all internal values, including coefficients in 3-variable linear equations and statistics. Values stored in memory in normal mode are not erased.



These arrow keys are useful for Multi-Line playback, which lets you scroll through calculation steps one by one. (refer to page 8)



These keys are useful for editing equations. The  key moves the cursor to the left, and the  key moves the cursor to the right. The  key deletes the symbol/number at the cursor. (refer to page 8)

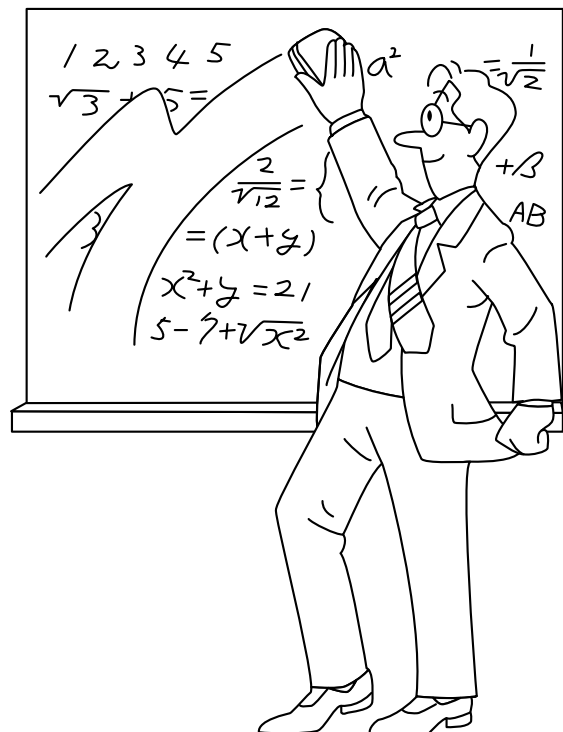

# Data Entry Keys

0 to 9 Numeric keys for entering data values.



Decimal point key. Enters a decimal point.



Enters minus symbol or sign change key.

Changes positive numbers to negative and negative numbers to positive.



Pressing  $\pi$  automatically enters the value for  $\pi$  (3.14159...).

The constant  $\pi$ , used frequently in function calculations, is the ratio of the circumference of a circle to its diameter.









Pressing this key switches to scientific notation data entry.

**<Example>** Provided the earth is moving around the sun in a circular orbit, how many kilometers will it travel in a year?

\* The average distance between the earth and the sun being  $1.496 \times 10^8$  km.

Circumference equals diameter  $\times \pi$ ; therefore,  
 $1.496 \times 10^8 \times 2 \times \pi$

<u>Operation</u>	<u>Display</u>
1  496  8	<div style="border: 1px solid black; padding: 5px; display: inline-block;"> <small>DEG</small>  <math>1.496 \times 10^8</math> </div>
 2   	<div style="border: 1px solid black; padding: 5px; display: inline-block;"> <small>DEG</small>  <math>1.496E08 \times 2 \times \pi \rightarrow</math>  <math>939964522.</math> </div>



# Random **RANDOM**

---

**RANDOM** Generates random numbers.

Random numbers are three-decimal-place values between 0.000 and 0.999. Using this function enables the user to obtain unbiased sampling data derived from random values generated by the calculator.

## <Example>

**2ndF** **RANDOM** **=** 0. \* \* \* (a random number has been generated)

**APPLICATIONS:**

Building sample sets for statistics or research.

# Modify

---

## **MDF**

Function to round calculation results.

Even after setting the number of decimal places on the display, the calculator performs calculations using a larger number of decimal places than that which appears on the display. By using this function, internal calculations will be performed using only the displayed value.

### <Example> FIX mode TAB = 1 (normal calculation)

$$5 \quad \div \quad 9 \quad = \quad 0.6 \quad (\text{internally, } 0.5555\dots)$$
$$\quad \times \quad 9 \quad = \quad 5.0$$

### Rounded calculation (MDF)





$$5 \quad \div \quad 9 \quad = \quad 0.6 \quad (\text{internally, } 0.5555\dots)$$
$$\quad \text{2ndF} \quad \text{MDF} \quad (\text{internally, } 0.6)$$
$$\quad \times \quad 9 \quad = \quad 5.4$$

APPLICATIONS:  
Frequently used in scientific and technical fields, as well as business, when performing chained calculations.

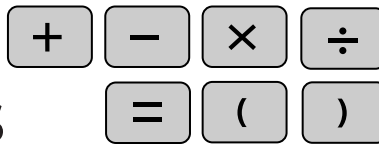

# Basic Arithmetic Keys, Parentheses

---



  The four basic operators. Each is used in the same way as a standard calculator:  
  + (addition), - (subtraction), x (multiplication), and ÷ (division).

 Finds the result in the same way as a standard calculator.

  Used to specify calculations in which certain operations have precedence. You can make addition and subtraction operations have precedence over multiplication and division by enclosing them in parentheses.

# Percent

---

For calculating percentages. Four methods of calculating percentages are presented as follows.

1) \$125 increased by 10%...137.5

125  +  10  2ndF  %

125+10%<sup>DEG</sup>  
137.5

2) \$125 reduced by 20%...100

125  -  20  2ndF  %

125-20%<sup>DEG</sup>  
100.

3) 15% of \$125...18.75

125  ×  15  2ndF  %

125×15%<sup>DEG</sup>  
18.75

4) When \$125 equals 5% of X, X equals...2500

125  ÷  5  2ndF  %

125÷5%<sup>DEG</sup>  
2500.

# Inverse, Square, xth Power of y, Square Root, Cube Root, xth Root of y

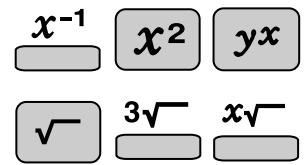

$x^{-1}$  Calculates the inverse of the value on the display.

$x^2$  Squares the value on the display.

$yx$  Calculates exponential values.

$\sqrt{\quad}$  Calculates the square root of the value on the display.  
(The EL-506R/520R need to press 2ndF key first)

$3\sqrt{\quad}$  Calculates the cube root of the value on the display.

$x\sqrt{\quad}$  Calculates the  $x^{\text{th}}$  root of y.

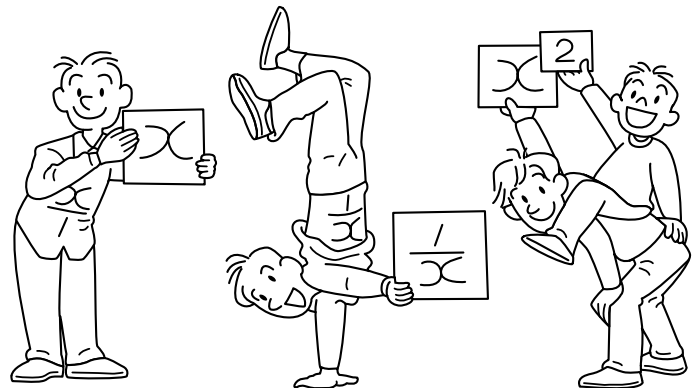

## <Example>

Operation	Display
2 $\times$ 2 $\times$ 2 $\times$ 2 =	$2 \times 2 \times 2 \times 2 =$ <sup>DEG</sup> 16.
2 $yx$ 4 =	$2^4 =$ <sup>DEG</sup> 16.
4 <b>2ndF</b> $x\sqrt{\quad}$ 16 =	$4 \times \sqrt{16} =$ <sup>DEG</sup> 2.

# 10 to the Power of x, Common Logarithm

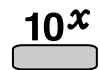

Calculates the value of 10 raised to the  $x^{\text{th}}$  power.



Calculates logarithm, the exponent of the power to which 10 must be raised to equal the given value.

## <Example>

Operation

Display

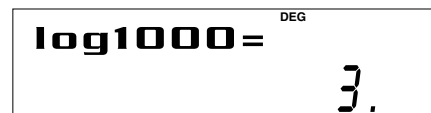
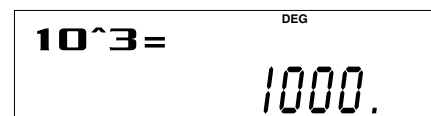
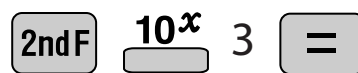

# e to the Power of x, Natural Logarithm

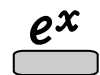
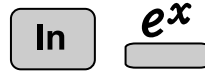





Calculates powers based on the constant e (2.718281828).

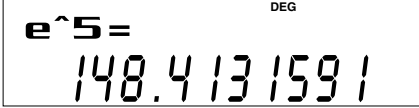

Computes the value natural logarithm, the exponent of the power to which e must be raised to equal the given value.

## <Example>

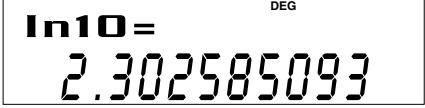
	<u>Operation</u>	<u>Display</u>
	  5 	
	 10 	

# Factorials $n!$

$n!$

The product of a given positive integer  $n$  multiplied by all the lesser positive integers from 1 to  $n-1$  is indicated by  $n!$  and called the factorial of  $n$ .

<Example>

Operation

7    2ndF     $n!$     =

Display

7! = DEG  
5040.

c.f  
 $n! = 1 \times 2 \times 3 \times \dots \times n$

APPLICATIONS:

Used in statistics and mathematics. In statistics, this function is used in calculations involving combinations and permutations.



# Permutations, Combinations $\frac{nPr}{\text{ }} \frac{nCr}{\text{ }}$

$\frac{nPr}{\text{ }}$

This function finds the number of different possible orderings in selecting  $r$  objects from a set of  $n$  objects. For example, there are six different ways of ordering the letters ABC in groups of three letters—ABC, ACB, BAC, BCA, CAB, and CBA.

The calculation equation is  ${}_3P_3 = 3 \times 2 \times 1 = 6$  (ways).

$\frac{nCr}{\text{ }}$

This function finds the number of ways of selecting  $r$  objects from a set of  $n$  objects. For example, from the three letters ABC, there are three ways we can extract groups of two different letters—AB, AC, and CB.

The calculation equation is  ${}_3C_2$ .

## <Example>

	Operation	Display
6	$\frac{2ndF}{\text{ }} \frac{nPr}{\text{ }} 4 =$	<div style="border: 1px solid black; padding: 5px; display: inline-block;"> <math>6P4=</math> <span style="float: right; font-size: small;">DEG</span>  <span style="font-size: 2em;">360.</span> </div>
6	$\frac{2ndF}{\text{ }} \frac{nCr}{\text{ }} 4 =$	<div style="border: 1px solid black; padding: 5px; display: inline-block;"> <math>6C4=</math> <span style="float: right; font-size: small;">DEG</span>  <span style="font-size: 2em;">15.</span> </div>

**APPLICATIONS:**  
 Used in statistics (probability calculations) and in simulation hypotheses in fields such as medicine, pharmaceuticals, and physics. Also, can be used to determine the chances of winning in lotteries.

# Time Calculation



Converts a sexagesimal value displayed in degrees, minutes, seconds to decimal notation. Also, converts a decimal value to sexagesimal notation (degrees, minutes, seconds).



Inputs values in sexagesimal notation (degrees, minutes, seconds).

**<Example>** Convert  $24^{\circ} 28' 35''$  (24 degrees, 28 minutes, 35 seconds) to decimal notation. Then convert  $24.476^{\circ}$  to sexagesimal notation.

## Operation

24  28  35

## Display



24° 28' 35

 

Convert to decimal notation



24° 28' 35.00°  
24.47638889



24° 28' 35.00°  
24° 28' 35.00

Repeat last key operation to return to the previous display.

**APPLICATIONS:**  
Used in calculations of angles and angular velocity in physics, and latitude and longitude in geography.

# Fractional Calculations

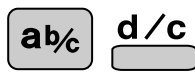

Inputs fractions and converts mutually between fractions and decimals.



Converts between mixed numbers and improper fractions.

**<Example>** Add  $3\frac{1}{2}$  and  $\frac{5}{7}$ , and convert to decimal notation.

<u>Operation</u>		<u>Display</u>
3		$3r1r2+5r7=$ $4r3r14.$
1		
2		
5		
7		



$3r1r2+5r7=$ $4.214285714$
-------------------------------

Convert to decimal notation

Press once to return to the previous display



$3r1r2+5r7=$ $59r14.$
--------------------------

Convert to an improper fraction

Press once to return to the previous display



$3r1r2+5r7=$ $4r3r14.$
---------------------------

## APPLICATIONS:

There is a wide variety of applications for this function because fractions are such a basic part of mathematics. This function is useful for calculations involving electrical circuit resistance.

# Memory Calculations

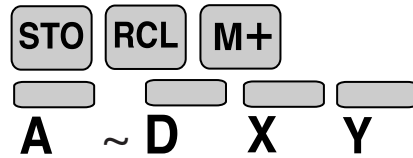

**STO**

Stores displayed values in memories A~D, X, Y, M.

**RCL**

Recalls values stored in A~D, X, Y, M.

**M+**

Adds the displayed value to the value in the independent memory M.

**A**

~ **D** **X** **Y**

Temporary memories

<Example>

Operation

Display

0 **STO** **M**  
(Enter 0 for M)

**0 ⇒ M** DEG  
0.

25 **×** 27 **M+**

**25x27M+** DEG M  
675.

7 **×** 3 **M+**

**7x3M+** DEG M  
21.

**RCL** **M**

**M =** DEG M  
696.

# Last Answer Memory

---

**ANS**  

Automatically recalls the last answer calculated by pressing 

<Example> Solve for x first and then solve for y using x.

$$x = \sqrt{2} + 3 \quad \text{and} \quad y = 4 \div x$$

Operation

 2  3 

Display

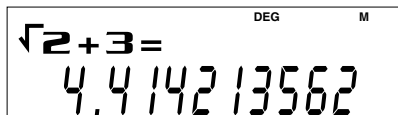

$\sqrt{2}+3=$   
4.414213562

4   **ANS**  

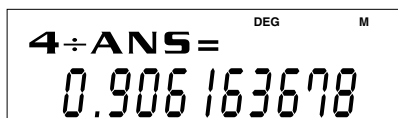

$4 \div \text{ANS} =$   
0.906163678

# Trigonometric Functions

sin

cos

tan

Trigonometric functions determine the ratio of three sides of a right triangle. Combination of three sides are sin, cos, and tan. Their relations are;

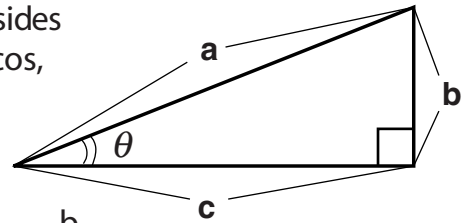

sin

Calculates the sine of an angle.

$$\sin \theta = \frac{b}{a}$$

cos

Calculates the cosine of an angle.

$$\cos \theta = \frac{c}{a}$$

tan

Calculates the tangent of an angle.

$$\tan \theta = \frac{b}{c}$$

## <Example>

The angle from a point 15 meters from a building to the highest floor of the building is  $45^\circ$ . How tall is the building?

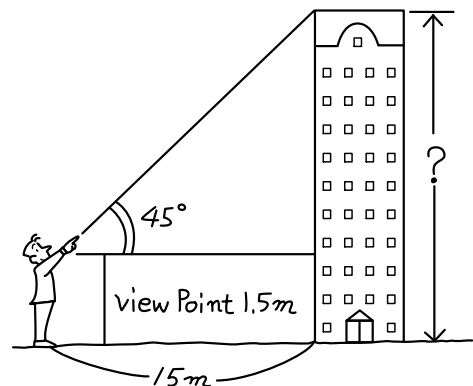

[DEG mode]

Operation

Display

tan 45 × 15  
+ 1 • 5 =

View point

tan45x15+1.5<sup>DEG</sup>  
16.5

### APPLICATIONS:

Trigonometric functions are useful in mathematics and various engineering calculations. They are often used in astronomical observations, civil engineering and in calculations involving electrical circuits, as well as in calculations for physics such as parabolic motion and wave motion.

# Arc Trigonometric Functions $\sin^{-1}$ $\cos^{-1}$ $\tan^{-1}$

Arc trigonometric functions, the inverse of trigonometric functions, are used to determine an angle from ratios of a right triangle. The combinations of the three sides are  $\sin^{-1}$ ,  $\cos^{-1}$ , and  $\tan^{-1}$ . Their relations are;

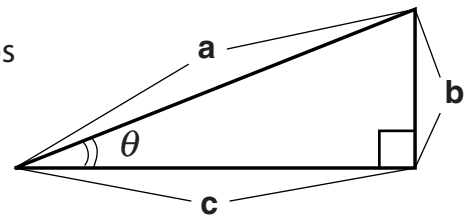

**$\sin^{-1}$**  (arc sine) Determines an angle based on the ratio  $b/a$  of two sides of a right triangle.  $\theta = \sin^{-1} \frac{b}{a}$

**$\cos^{-1}$**  (arc cosine) Determines an angle based on the ratio  $c/a$  for two sides of a right triangle.  $\theta = \cos^{-1} \frac{c}{a}$

**$\tan^{-1}$**  (arc tangent) Determines an angle based on the ratio  $b/c$  for two sides of a right triangle.  $\theta = \tan^{-1} \frac{b}{c}$

### <Example>

At what angle should an airplane climb in order to climb 80 meters in 100 meters?

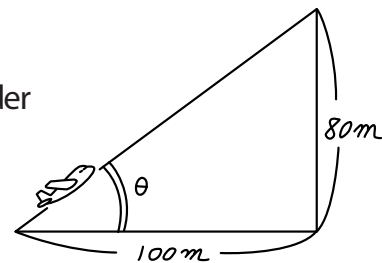

[DEG mode]

Operation

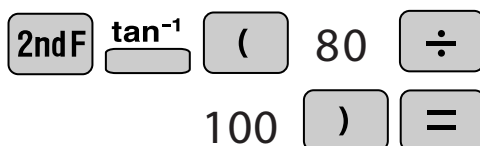

Display

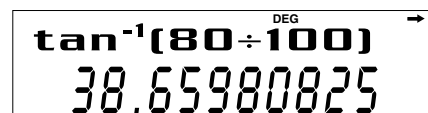

# Hyperbolic Functions

hyp

arc  
hyp

---

For the EL-506R, select  $\sinh$ ,  $\sin^{-1}$ ,  $\cosh$ ,  $\cosh^{-1}$ ,  $\tanh$ ,  $\tanh^{-1}$  from the MATH key

hyp

The hyperbolic function is defined by using natural exponents in trigonometric functions.

arc  
hyp

Arc hyperbolic functions are defined by using natural logarithms in trigonometric functions.

**APPLICATIONS:**

Hyperbolic and arc hyperbolic functions are very useful in electrical engineering and physics.



# Coordinate Conversion $\rightarrow r\theta$ $\rightarrow xy$ , $\leftarrow, \rightarrow$

For the EL-506R, select  $\rightarrow r, \theta$  and  $\rightarrow x, y$  from the MATH key

$\rightarrow r\theta$   
 Converts rectangular coordinates to polar coordinates ( $x, y \rightarrow r, \theta$ )

$\rightarrow xy$   
 Converts polar coordinates to rectangular coordinates ( $r, \theta \rightarrow x, y$ )

,  
 Splits data used for dual-variable data input.

$\leftarrow, \rightarrow$   
 Displays  $r, \theta$  and  $x, y$ . ( $Cx \rightleftharpoons y$  or  $r \rightleftharpoons \theta$ )

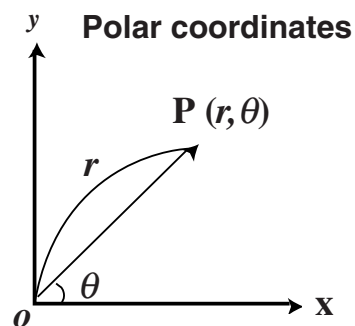
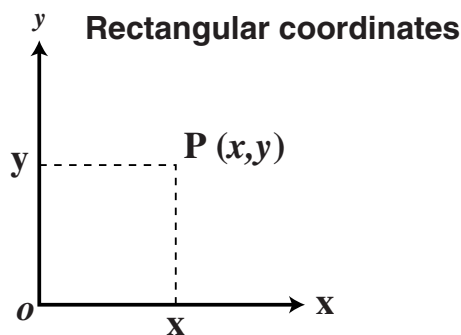

**<Example>** Determine the polar coordinates ( $r, \theta$ ) when the rectangular coordinates of Point P are ( $x = 7, y = 3$ ).

[DEG mode]

Operation		Display
7	$\text{2ndF}$ , $\text{2ndF}$ $\rightarrow r\theta$	$r =$ 7.615773106
	$\text{2ndF}$ $\leftarrow, \rightarrow$	$\theta =$ 23.19859051
7.6	$\text{2ndF}$ , $\text{2ndF}$ $\rightarrow xy$	$x =$ 6.985428578
	$\text{2ndF}$ $\leftarrow, \rightarrow$	$y =$ 2.993958513

Operation example using the EL-531VH/  
 EL-509V

## APPLICATIONS:

Coordinate conversion is often used in mathematics and engineering, especially for impedance calculations in electronics and electrical engineering.

# Statistics Function

The statistics function is excellent for analyzing qualities of an event. Though primarily used for engineering and mathematics, the function is also applied to nearly all other fields including economics and medicine.

## DATA INPUT AND ERASE

 Enters data for statistical calculations.

 Clears last data input.







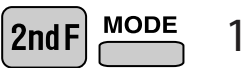
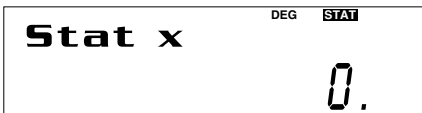

 Splits data used for dual-variable data input.  
(Used for dual-variable statistical calculations.)

**<Example 1>** Here is a table of examination results. Input this data for analysis (along with data correction).

Data table 1

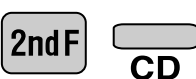
No.	1	2	3	4	5	6	7	8
Score	30	40	50	60	70	80	90	100
No. of pupils	2	4	5	7	12	10	8	2

**[Select single-variable statistics mode]**

<u>Operation</u>	<u>Display</u>
 Select single-variable statistics mode	
30 	
100 	
In this case, the last data entry has been incorrectly input for the number of pupils.	
	 (final data cleared)
 Score                  Number of pupils	 (correct data input)

Data total up to this point

## "ANS" KEYS FOR 1-VARIABLE STATISTICS

$\bar{x}$   
[ ]

Calculates the average for input data (sample data x).

$s_x$   
[ ]

Calculates the standard deviation of samples from input data (sample data x).

$\sigma_x$   
[ ]

Calculates the standard deviation for a population from input data (sample data x).

$n$   
[ ]

Displays the number of input data (sample data x).

$\Sigma x$   
[ ]

Calculates the total for input data (sample data x).

$\Sigma x^2$   
[ ]

Calculates the total to the second power for input data (sample data x).

### NOTE:

1. Sample data refers to data selected randomly from the population.
2. Standard deviation of samples is determined by the sample data shift from an average value.
3. Standard deviation for the population is standard deviation when the sample data is deemed a population (full data).

<Let's check the results based on the previous data.>

**RCL**  $\bar{x}$   
[ ]

69 (average value)

**RCL**  $s_x$   
[ ]

17.75686128 (standard deviation)

**RCL**  $\sigma_x$   
[ ]

17.57839583 (standard deviation of the population)

**RCL**  $n$   
[ ]

50 (total count of data)

**RCL**  $\Sigma x$   
[ ]

3450 (total)

### APPLICATIONS:

Single-variable statistical calculations are used in a broad range of fields, including engineering, business and economics. They are most often applied to analysis in atmospheric observations and physics experiments, as well as for quality control in factories.

<Example 2> The table below summarizes the dates in April when cherry blossoms bloom, and the average temperature for March in that same area. Determine basic statistical quantities for data X and data Y based on the data table.

<Data table 2>

	Year	1983	1984	1985	1986	1987	1988	1989	1990
x	Average temperature	6.2	7.0	6.8	8.7	7.9	6.5	6.1	8.2
y	Date blossoms bloom	13	9	11	5	7	12	15	7

2ndF MODE 2

Stat xy DEG STAT 0.

Select dual-variable statistics mode

6 [•] 2 [(x,y)] 13 [DATA]  
⋮  
⋮  
⋮

n= DEG STAT 1.

6 [•] 1 [(x,y)] 15 [DATA]

n= DEG STAT 7.

8 [•] 2 [(x,y)] 7 [DATA]  
Temperature Date

n= DEG STAT 8.

Data total up to this point

## “ANS” KEYS FOR 2-VARIABLE STATISTICS

In addition to the 1-variable statistic keys, the following keys have been added for calculating 2-variable statistics.

$\Sigma xy$	Calculates the sum of the product for sample data X and sample data Y.
$\Sigma y$	Calculates the sum of the data (sample data Y).
$\Sigma y^2$	Calculates the sum of the data (sample data Y) raised to the second power.
$\bar{y}$	Calculates the average value of the data (sample data Y).
$\sigma y$	Calculates the standard deviation of a data population (sample data Y).
$sy$	Calculates the standard deviation for the data (sample data Y).

NOTE:

The codes for basic statistical quantities of sample data X and their meanings are the same as those for single-variable statistical calculations.

<Let's check the results based on the previous data.>

<b>RCL</b>	$\bar{x}$	7.175	(Average for data X)
<b>RCL</b>	$sx$	0.973579551	(Standard deviation for data X)
<b>RCL</b>	$\sigma x$	0.91070028	(Standard deviation of the population for data X)
<b>RCL</b>	$\bar{y}$	9.875	(Average for data Y)
<b>RCL</b>	$sy$	3.440826313	(Standard deviation for data Y)
<b>RCL</b>	$\sigma y$	3.218598297	(Standard deviation of the population for data Y)
<b>RCL</b>	$n$	8	(Total count of data)
<b>RCL</b>	$\Sigma x$	57.4	(Sum of data X)
<b>RCL</b>	$\Sigma x^2$	418.48	(Data X raised to the second power)
<b>RCL</b>	$\Sigma xy$	544.1	(Sum of the product of data X and data Y)
<b>RCL</b>	$\Sigma y$	79	(Sum of data Y)
<b>RCL</b>	$\Sigma y^2$	863	(Data Y raised to the second power)

**SHARP**  
SHARP CORPORATION OSAKA, JAPAN